



AfrinIC



AfrinIC-9

22 - 28 Nov 08

Mauritius

Technical Operation Area Report

AfrinIC-9

Mauritius, 28th November 2008

Alain Patrick AINA
aalain@afriNIC.net

Spearheading Internet technology and policy development in the

What we do



The TOA



Infrastructure

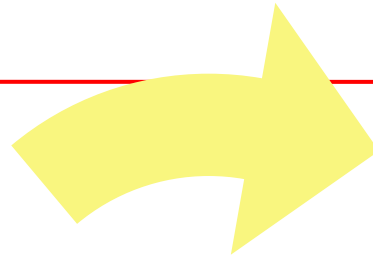

Database+Soft



Services





Registration Services

- - IP allocations and assignments
 - 41/8, 196/8, 197/8
 - 2001:4200::/23, 2C00:0000::/12

- - ASN Assignments
 - AS32768 - AS33791
 - AS36864 - AS37887
 - AS327680 – AS328703(AS5.1- AS5.1023)

- - RDNS
- - Stats
- - Helpdesk



Services

- AIRRS
- DNS
- eGroupware
- Email
- FTP
- Mailing Lists
- Meeting Registration
- MyAfrinIC
- Support Ticketing
- Website
- Whois
- VOIP
- **IRR**

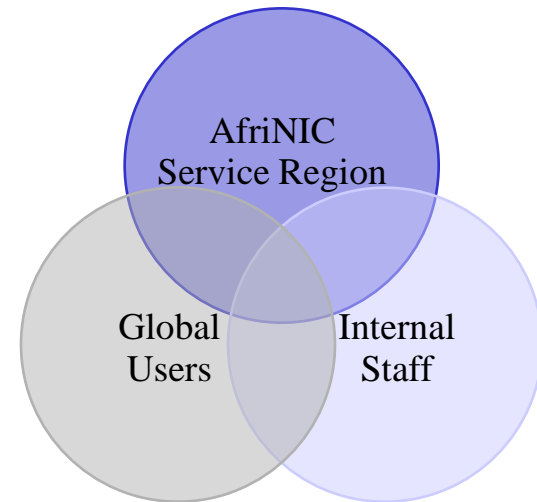



Infrastructure

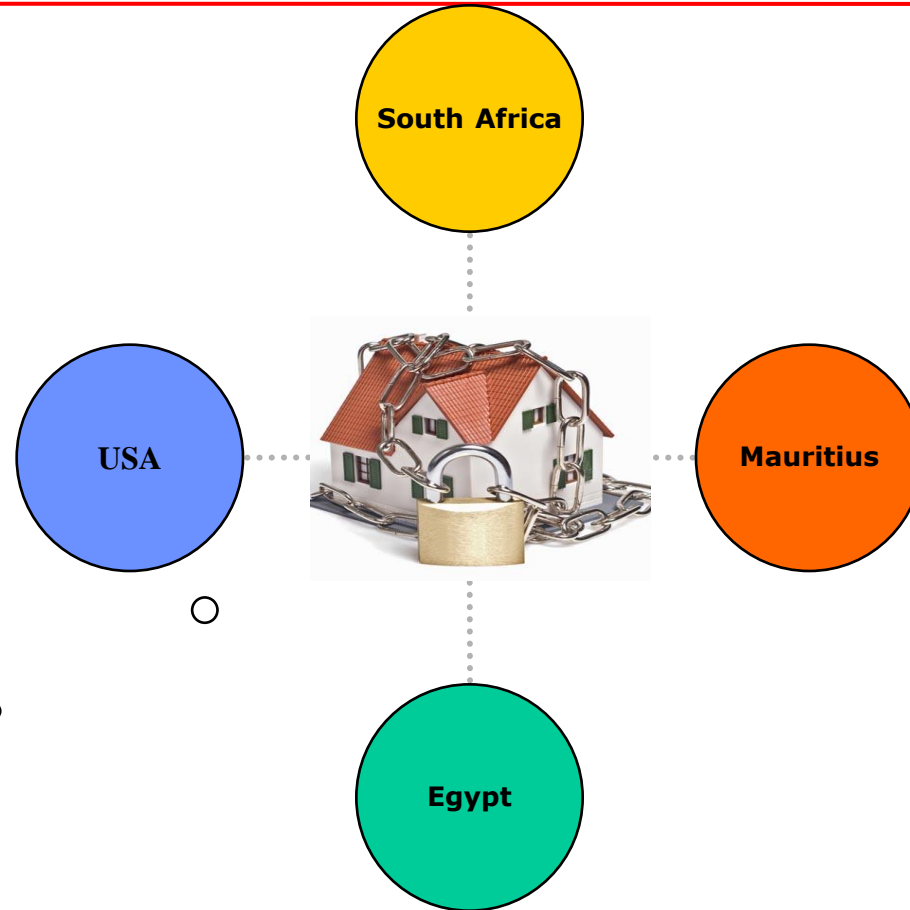

Database and software

- Databases Maintenance and Enhancement
- New Service Development
 - MyAfrinIC Membership Portal
 - Meeting Registration
- Core Service Enhancement
 - Whois Server
 - Reverse DNS Zone Update & Publishing
 - Graphical Statistics
- Member + Staff Tools
 - Delegation Checker
 - Resource Registration Calculators
- Third-party Software Install and Customization



- Help Documentation
- Whois
- Software Changes/Bug Fixes
- Systems
 - User Administration
 - Server, Service and Network Monitoring
 - Security Auditing
- Technical Setups
 - AfrinIC Meeting
 - Staff Conferences
- Other Issues



Global Participation

- AfrinIC Mailing Lists
- Engineering Coordination Group (ECG) of Number Resource organization (NRO)
 - Undertake yearly joint activities with other RIRs
 - meet once-a-month via teleconference/meeting
 - Chair rotates between each RIR
- IETF
 - Participate in standards development
 - Implement relevant RFC standards
- AfNOG/NANOG/RIPE

Activities report



Activities Update(1)

- ▶ Registration services update given by RSM
- ▶ Myafrinic portal maintenance and improvement
 - Bugs and new features
- ▶ Internet Routing Registry
 - Internal testings ongoing
 - Community testings to follow
 - Deployment plan

Activities Update(2)

▶ % Information related to '2001:4310:0810::/44AS5.1'

route6: 2001:4310:0810::/44

descr: TEST 6

origin: AS5.1

holes: 2001:4310:0815:8000::/49, 2001:4310:081e:8000::/49

aggr-mtd: outbound AS-ANY

inject: at 1.1.1.1 action dpa = 100;

inject: at 1.1.1.2 action dpa = 110;

aggr-bndry: AS1 or AS2 or AS3

export-comps: {003c:0000:2600::/48}

mnt-lower: ERNEST-MMM

mnt-by: ERNEST-MMM

changed: rr@hu.ki 20081128

source: TEST

Activities Update(3)

- ▶ Infrastructure maintenance and improvement
 - New services
 - Performance
 - Security
 - Policies
- ▶ IPv6 Rollout
 - Concluding testings
 - Production deployment to start

Activities Update(4)

RIPE NCC Test traffic Measurements

- Hosting a box under AS2905 in Johannesburg

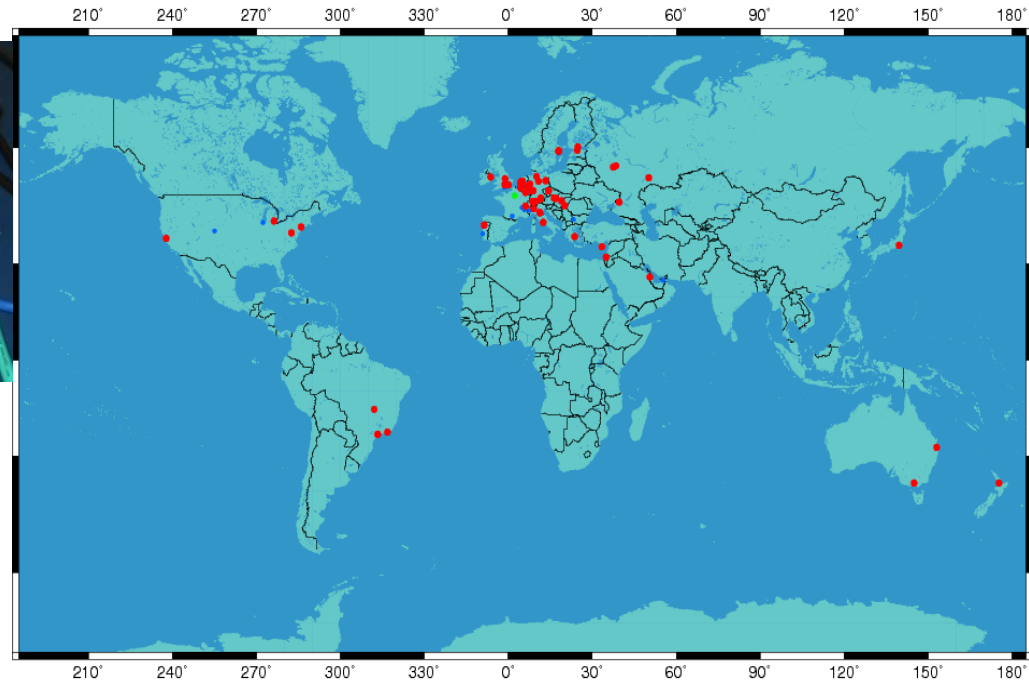
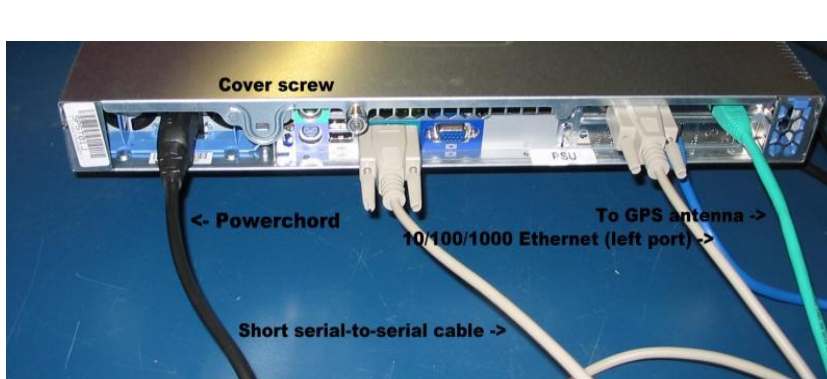

Activities Update(5)

- ▶ Virtual lab
 - 6deploy activity
 - 1st in AfrinIC service region
 - 3 core routers and 3 edge routers
 - v6/v4
 - For training and experiments
 - A reservation system to handle the utilization

Activities Update(6)

► Virtual lab: Test network

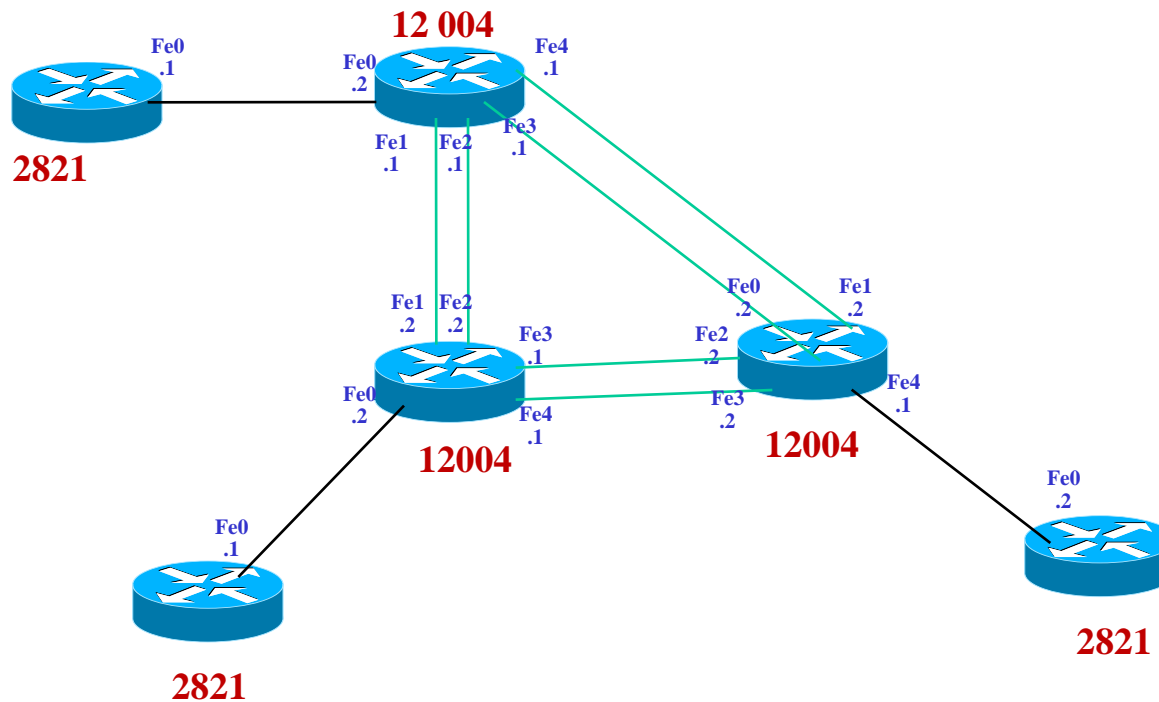



Activities Update(7)

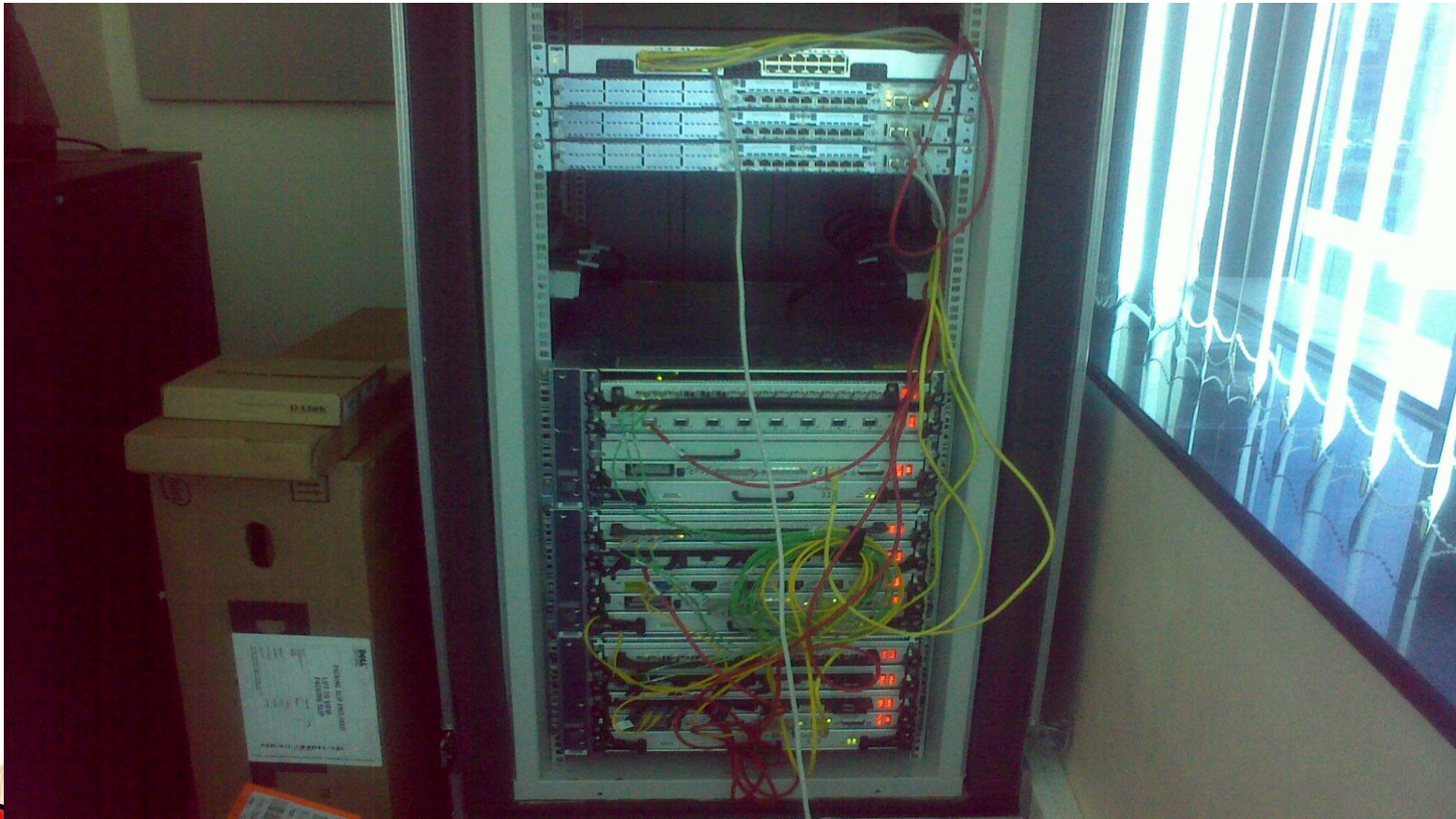

The virtual Lab(seen physically)

Activities Update(8)

- ▶ Training
 - TOA team gives training
 - LIR/IPv6
 - IPv6-v1, IPv6-v2
 - English and French
 - 12+1 sessions in 2008



Thank you for attention

